

Wrenches

The first of Blue-Point wrenches were designed to be unable to break at its head, spread the jaws, bend its handle, injure them nor destroy their everlasting efficiency. While most of our wrenches have evolved and improved with times, these core philosophies to quality are observed till today in our design and manufacturing.

Our ratchets have more number of teeth than competing brands of the same level, so that you need to turn less to tighten or loosen the same bolt. In short, you do less work. We also incorporate flexible box end head in some of our designs to accommodate to awkward tool working angles.

All our wrenches feature nickel chrome finish for corrosion resistance and a more durable finish. Our design kept the thickness of the jaws to the minimal without losing its required strength. This allows our wrench to reach better into constricted openings for any tightening or loosening task. Each open end wrench also feature heads set at different and appropriate angles so that you can flip it four ways to get the best working angle.

Wrenches

Wrench Sets	34
Adjustable Wrenches	36
Combination Wrenches	36
Ratcheting Wrenches	37



Adjustable Wrench Set, 3pcs

BLPADJ703



- Includes GAJ15A (15"), GAJ18A (18") and GAJ24A (24") adjustable wrenches

Adjustable Wrench Set, 4pcs

BLPADJ404



- Includes GAJ6A (6"), GAJ8A (8"), GAJ10A (10") and GAJ12A (12") adjustable wrenches

Adjustable Wrench Set, 3pcs

BADJC703



- Includes BADJC6 (6"), BADJC8 (8") and BADJC10 (10") composite handle adjustable wrenches

Adjustable Wrench Set, 4pcs

BLPADJ404SG



- Includes GAJ6SG (6"), GAJ8SG (8"), GAJ10SG (10") and GAJ12SG (12") adjustable wrenches

Combination Wrench Set, 12pcs

BLPCWSM712



- Includes 8 to 19mm combination wrenches
- | | | |
|----------|----------|----------|
| BLPCWM8 | BLPCWM12 | BLPCWM16 |
| BLPCWM9 | BLPCWM13 | BLPCWM17 |
| BLPCWM10 | BLPCWM14 | BLPCWM18 |
| BLPCWM11 | BLPCWM15 | BLPCWM19 |

Combination Wrench Set, 11pcs

BLPCWS711



- Includes 3/8" to 1" combination wrenches
- | | | |
|----------|-----------|-----------|
| BLPCW38 | BLPCW58 | BLPCW78 |
| BLPCW716 | BLPCW1116 | BLPCW1516 |
| BLPCW12 | BLPCW34 | BLPCW1 |
| BLPCW916 | BLPCW1316 | |

Ratcheting Wrench Set



- BOERM712**
- Includes 8 to 19mm ratchet combination wrenches
- | | | |
|---------|---------|---------|
| BOERM8 | BOERM12 | BOERM16 |
| BOERM9 | BOERM13 | BOERM17 |
| BOERM10 | BOERM14 | BOERM18 |
| BOERM11 | BOERM15 | BOERM19 |

- BOERM704**
- Includes BOERM21, BOERM22, BOERM24 and BOERM25 (21 to 25mm) ratchet combination wrenches

Ratcheting Wrench Set



- BOER708**
- Includes 5/16" to 3/4" ratchet combination wrenches
- | | |
|--------|--------|
| BOER10 | BOER18 |
| BOER12 | BOER20 |
| BOER14 | BOER22 |
| BOER16 | BOER24 |

- BOER704**
- Includes BOER26, BOER28, BOER30 and BOER32 (13/16" to 1") ratchet combination wrenches

Ratcheting Wrench Set, 12pcs

BOERMF712A



- Includes 8 to 19mm flexible head ratchet combination wrenches
- | | | |
|-----------|-----------|-----------|
| BOERMF8A | BOERMF12A | BOERMF16A |
| BOERMF9A | BOERMF13A | BOERMF17A |
| BOERMF10A | BOERMF14A | BOERMF18A |
| BOERMF11A | BOERMF15A | BOERMF19A |

Ratcheting Wrench Set, 8pcs

BOERF708A



- Includes 5/16" to 3/4" flexible head ratchet combination wrenches
- | | |
|----------|----------|
| BOERF10A | BOERF18A |
| BOERF12A | BOERF20A |
| BOERF14A | BOERF22A |
| BOERF16A | BOERF24A |

Ratcheting Wrench Set, 12pcs

BOERMS712



- Includes 8 to 19mm flexible head ratchet combination wrenches
- | | | |
|----------|----------|----------|
| BOERMS8 | BOERMS12 | BOERMS16 |
| BOERMS9 | BOERMS13 | BOERMS17 |
| BOERMS10 | BOERMS14 | BOERMS18 |
| BOERMS11 | BOERMS15 | BOERMS19 |

Ratcheting Wrench Set, 8pcs

BOERS708



- Includes 5/16" to 3/4" flexible head ratchet combination wrenches
- | | |
|---------|---------|
| BOERS10 | BOERS18 |
| BOERS12 | BOERS20 |
| BOERS14 | BOERS22 |
| BOERS16 | BOERS24 |

Ratcheting Wrench Set, 12pcs

BOERMSF712



- Includes 8 to 19mm short ratchet combination wrenches
- | | | |
|-----------|-----------|-----------|
| BOERMSF8 | BOERMSF12 | BOERMSF16 |
| BOERMSF9 | BOERMSF13 | BOERMSF17 |
| BOERMSF10 | BOERMSF14 | BOERMSF18 |
| BOERMSF11 | BOERMSF15 | BOERMSF19 |

Ratcheting Wrench Set, 8pcs

BOERSF708



- Includes 5/16" to 3/4" short ratchet combination wrenches
- | | |
|----------|----------|
| BOERSF10 | BOERSF18 |
| BOERSF12 | BOERSF20 |
| BOERSF14 | BOERSF22 |
| BOERSF16 | BOERSF24 |

Ratcheting Wrench Set, 12pcs

BOERMFLCG712



- Includes 8 to 19mm locking flexible head ratchet combination wrenches
- | | | |
|-------------|-------------|-------------|
| BOERMFLCG8 | BOERMFLCG12 | BOERMFLCG16 |
| BOERMFLCG9 | BOERMFLCG13 | BOERMFLCG17 |
| BOERMFLCG10 | BOERMFLCG14 | BOERMFLCG18 |
| BOERMFLCG11 | BOERMFLCG15 | BOERMFLCG19 |

Ratcheting Wrench Set, 8pcs

BOERFLCG708



- Includes 5/16" to 3/4" locking flexible head ratchet combination wrenches
- | | |
|------------|------------|
| BOERFLCG10 | BOERFLCG18 |
| BOERFLCG12 | BOERFLCG20 |
| BOERFLCG14 | BOERFLCG22 |
| BOERFLCG16 | BOERFLCG24 |

Ratcheting Box Wrench Set, 5pcs

RBZM605



- Includes 7-8 to 15-17mm ratcheting box wrenches
- | | |
|----------|----------|
| RBZM78 | RBZM1314 |
| RBZM910 | RBZM1517 |
| RBZM1112 | |

Ratcheting Box Wrench Set, 5pcs

RBZ605



- Includes 1/4" - 5/16" to 3/4" - 7/8" ratcheting box wrenches
- | | |
|---------|---------|
| RBZ810 | RBZ2022 |
| RBZ1214 | RBZ2428 |
| RBZ1618 | |

Adjustable



Stock No.	A (mm)	L (mm)
GAJ4A	13	108
GAJ6A	25	160
GAJ8A	29	210
GAJ10A	33	260
GAJ12A	38	310
GAJ15A	43	385
GAJ18A	52	450
GAJ24A	62	610
GAJ30A	85	778

- Wrench features a durable black phosphate finish
- Wide-open jaw design with polished head
- Heat treated steel alloy construction
- Inch scale laser etched on head face

Adjustable, Composite Grip



Stock No.	A (mm)	L (mm)
BADJC6	25	164
BADJC8	30	218
BADJC10	35	267

- Ergonomic, lightweight handle design reduces fatigue while providing easier gripping and greater balance
- Inch scale is laser etched on face
- Fully polished head
- Durable heat treated alloy construction

Adjustable, Soft Grip



Stock No.	A (mm)	L (mm)
GAJ6SG	25	160
GAJ8SG	29	210
GAJ10SG	33	260
GAJ12SG	38	310

- Now the most popular Blue-Point® Adjustable Wrenches are available with soft grips
- Durable black phosphate finish
- Wide open jaw design with oversized capacity
- Laser-etched SAE/metric scale for easy determination of bolt size
- Soft Grip design for added comfort

Combination

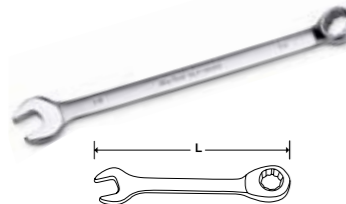

Stock No.	mm	L (mm)	Stock No.	mm	L (mm)
BLPCWM6	6	128	BLPCWM19	19	281
BLPCWM7	7	135	BLPCWM20	20	301
BLPCWM8	8	148	BLPCWM21	21	301
BLPCWM9	9	160	BLPCWM22	22	319
BLPCWM10	10	167	BLPCWM23	23	329
BLPCWM11	11	186	BLPCWM24	24	339
BLPCWM12	12	196	BLPCWM27	27	372
BLPCWM13	13	205	BLPCWM30	30	413
BLPCWM14	14	223	BLPCWM32	32	432
BLPCWM15	15	233	BLPCWM36	36	432
BLPCWM16	16	243	BLPCWM38	38	432
BLPCWM17	17	262	BLPCWM41	41	445
BLPCWM18	18	272	BLPCWM46	46	483

Combination

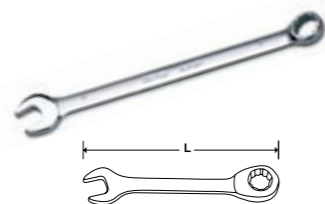

Stock No.	mm	L (mm)
BLPCW14	1/4	128
BLPCW516	5/16	148
BLPCW38	3/8	167
BLPCW716	7/16	186
BLPCW12	1/2	205
BLPCW916	9/16	223
BLPCW58	5/8	243
BLPCW1116	11/16	262
BLPCW34	3/4	281
BLPCW1316	13/16	301
BLPCW78	7/8	319
BLPCW1516	15/16	339
BLPCW1	1	358

- Manufactured from high grade steel alloy
- Features a Lifetime Warranty and exceeds ANSI Standards

Open End

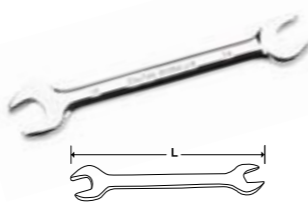

Stock No.	mm	L (mm)
BDOEM1011	10 - 11	145
BDOEM1213	12 - 13	165
BDOEM1415	14 - 15	185
BDOEM1617	16 - 17	185
BDOEM1819	18 - 19	227

Open End

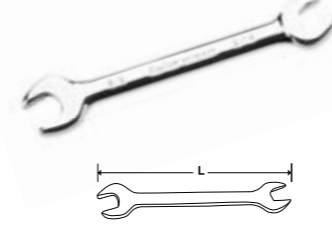

Stock No.	mm	L (Inches)
BDOE1012	5/16-3/8	5 5/16
BDOE1416	7/16-1/2	6 1/2
BDOE1820	9/16-5/8	7 9/32
BDOE2224	11/16-3/4	8 15/16

T-Shape

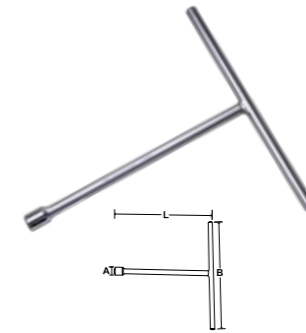

Stock No.	A (mm)	B (mm)	L (mm)
BPTHM08	8	200	250
BPTHM09	9	200	250
BPTHM10	10	200	250
BPTHM11	11	200	250
BPTHM12	12	250	250
BPTHM13	13	250	300
BPTHM14	14	250	300

- Speedy socket wrench, convenience for use
- Magnetic inset for convenience

Ratchet Combination

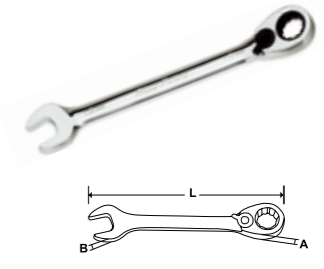

Stock No.	mm	A (mm)	B (mm)	L (mm)
BOERM6	6	6.6	3.6	114
BOERM7	7	6.6	3.9	125
BOERM8	8	6.5	4.0	135
BOERM9	9	7.4	4.0	150
BOERM10	10	8.0	5.0	160
BOERM11	11	8.5	5.5	170
BOERM12	12	9.0	5.5	175
BOERM13	13	10.0	6.3	180
BOERM14	14	10.0	6.5	190
BOERM15	15	11.0	7.0	200
BOERM16	16	11.0	7.0	210
BOERM17	17	12.0	7.0	230
BOERM18	18	12.0	8.0	240
BOERM19	19	12.9	8.7	250
BOERM21	21	13.7	9.4	266
BOERM22	22	14.5	9.4	286
BOERM24	24	15.5	11.2	305
BOERM25	25	15.5	11.2	327

- Dual pawl ratcheting box end yields smooth operation and maximum strength
- 15° offset box head provides extra knuckle clearance
- 4.5° (5° on smaller wrenches) gear engagement means less movement to engage the next gear
- Inch scale laser etched on head face
- Ratcheting box is reversible
- Box end features the FLANK DRIVE® wrenching configuration for greater torque with less applied force
- Tough, durable nickel-chrome finish
- Meets or exceeds strength specifications in ASME B107.6

Ratchet Combination

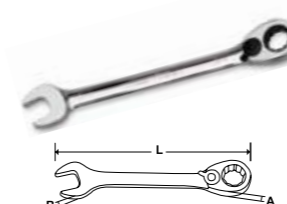

Stock No.	mm	A (inches)	B (inches)	L (inches)
BOER8	1/4	1/4	5/32	4 1/2
BOER10	5/16	1/4	5/32	5 5/16
BOER12	3/8	5/16	3/16	6 5/16
BOER14	7/16	11/32	7/32	6 11/16
BOER16	1/2	13/32	1/4	7 1/16
BOER18	9/16	13/32	1/4	7 1/2
BOER20	5/8	7/16	9/32	8 1/4
BOER22	11/16	15/32	9/32	9 1/16
BOER24	3/4	1/2	11/32	9 13/16
BOER26	13/16	17/32	3/8	10 1/2
BOER28	7/8	9/16	3/8	11 1/4
BOER30	15/16	5/8	7/16	12
BOER32	1	5/8	7/16	12 7/8

Ratchet Combination

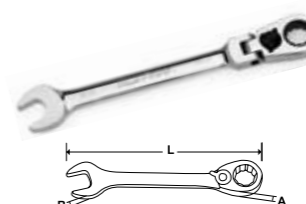

Stock No.	mm	A (mm)	B (mm)	L (mm)
BOERMF8A	8	6.5	4.0	142
BOERMF9A	9	7.4	4.0	152
BOERMF10A	10	8.0	5.0	162
BOERMF11A	11	8.5	5.5	172
BOERMF12A	12	9.0	5.5	180
BOERMF13A	13	10.0	6.3	188
BOERMF14A	14	10.0	6.5	196
BOERMF15A	15	11.0	7.0	204
BOERMF16A	16	11.0	7.0	214
BOERMF17A	17	12.0	7.0	228
BOERMF18A	18	12.0	8.0	242
BOERMF19A	19	12.9	8.7	256

Ratchet Combination

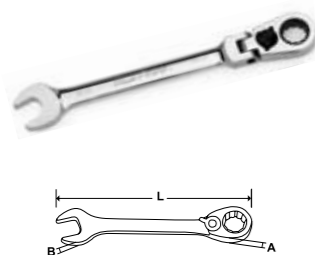

Stock No.	mm	A (inches)	B (inches)	L (inches)
BOERF10A	5/16	1/4	5/32	5 19/32
BOERF12A	3/8	5/16	3/16	6 3/8
BOERF14A	7/16	11/32	7/32	6 3/4
BOERF16A	1/2	13/32	1/4	7 13/32
BOERF18A	9/16	13/32	1/4	7 23/32
BOERF20A	5/8	7/16	9/32	8 7/16
BOERF22A	11/16	15/32	9/32	8 31/32
BOERF24A	3/4	1/2	11/32	10 1/16

Short Ratchet Combination



Stock No.	mm	A (mm)	B (mm)	L (mm)
BOERMS8	8	6.5	4.0	90
BOERMS9	9	7.4	4.0	95
BOERMS10	10	8.0	5.0	100
BOERMS11	11	8.5	5.5	105
BOERMS12	12	9.0	5.5	110
BOERMS13	13	10.0	6.3	115
BOERMS14	14	10.0	6.5	120
BOERMS15	15	11.0	7.0	125
BOERMS16	16	11.0	7.0	128
BOERMS17	17	12.0	7.0	132
BOERMS18	18	12.0	8.0	138
BOERMS19	19	12.9	8.7	142

Short Ratchet Combination



Stock No.	mm	A (inches)	B (inches)	L (inches)
BOERS10	5/16	1/4	5/32	3 9/16
BOERS12	3/8	5/16	3/16	3 15/16
BOERS14	7/16	11/32	7/32	4 1/8
BOERS16	1/2	13/32	1/4	4 1/2
BOERS18	9/16	13/32	1/4	4 3/4
BOERS20	5/8	7/16	9/32	5 1/16
BOERS22	11/16	15/32	9/32	5 3/16
BOERS24	3/4	1/2	11/32	5 9/16

- Flex head pivots 90 degrees in either direction
- Stubby length improves access and knuckle clearance to hard to reach fasteners
- Dual pawl reversible ratcheting box end
- Low profile easy action reverse lever won't get in your way
- Tough, durable nickel chrome finish
- Up to 80 gear teeth for ratcheting in tight areas

Short Ratchet Combination



Stock No.	mm	A (mm)	B (mm)	L (mm)
BOERMSF8	8	6.5	4.0	94
BOERMSF9	9	7.4	4.0	98
BOERMSF10	10	8.0	5.0	103
BOERMSF11	11	8.5	5.5	108
BOERMSF12	12	9.0	5.5	111
BOERMSF13	13	10.0	6.3	115
BOERMSF14	14	10.0	6.5	120
BOERMSF15	15	11.0	7.0	124
BOERMSF16	16	11.0	7.0	128
BOERMSF17	17	12.0	7.0	133
BOERMSF18	18	12.0	8.0	140
BOERMSF19	19	12.9	8.7	147

Flex Head Ratchet Combination



Stock No.	mm	A (inches)	B (inches)	L (inches)
BOERSF10	5/16	1/4	5/32	3 11/16
BOERSF12	3/8	5/16	3/16	4 1/16
BOERSF14	7/16	11/32	7/32	4 1/4
BOERSF16	1/2	13/32	1/4	4 17/32
BOERSF18	9/16	13/32	1/4	4 23/32
BOERSF20	5/8	7/16	9/32	5 1/32
BOERSF22	11/16	15/32	9/32	5 1/4
BOERSF24	3/4	1/2	11/32	5 25/32

Ratcheting Box



Stock No.	mm	A (mm)	L (mm)
RBZM78	7-8	15.1-17.1	114
RBZM910	9-10	20.4-22.6	140
RBZM1112	11-12	25.8-29.4	175
RBZM1314	13-14	25.8-29.4	175
RBZM1517	15-17	32.9-36.5	206
RBZM1618	16-18	32.9-36.5	206
RBZM1921	19-21	35.7-40.1	235

Ratcheting Box



Stock No.	mm	A (inches)	L (inches)
RBZ810	1/4-5/16	3/8	4 1/2
RBZ1214	3/8-7/16	3/8	5 7/2
RBZ1618	1/2-9/16	1/2	6 1/8
RBZ2022	5/8-11/16	1/2	9 1/4
RBZ2428	3/4-7/8	1/2	9 1/4

Locking Flex Head Ratchet

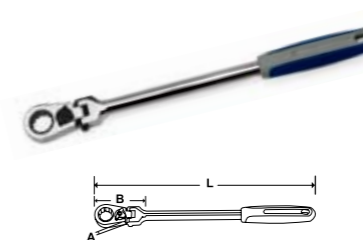

Stock No.	mm	A (inches)	B (inches)	L (inches)
BOERFLCG10	5/16	1/4	1 1/4	9
BOERFLCG12	3/8	5/16	1 1/2	8 1/4
BOERFLCG14	7/16	11/32	1 9/16	9 19/32
BOERFLCG16	1/2	13/32	1 25/32	11 9/32
BOERFLCG18	9/16	13/32	1 29/32	11 3/8
BOERFLCG20	5/8	7/16	2 1/8	13 21/32
BOERFLCG22	11/16	15/32	2 7/32	13 23/32
BOERFLCG24	3/4	1/2	2 17/32	13 15/16

- Corrosive resistant bi-mold cushion grips for improved comfort and performance
- Wrenches have multiple locking head positions for easier access to tough to reach fasteners
- Long reach solid shank steel handle for improved reach and leverage
- Dual pawl reversible ratchet head
- Flex head pivots 90 degrees in either direction

Locking Flex Head Ratchet

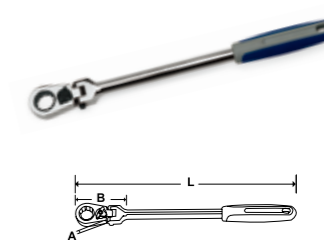

Stock No.	mm	A (mm)	B (mm)	L (mm)
BOERMFLCG8	8	6.55	32	228
BOERMFLCG9	9	7.45	34	229
BOERMFLCG10	10	8.05	38	233
BOERMFLCG11	11	8.55	40	235
BOERMFLCG12	12	9.05	42	285
BOERMFLCG13	13	10.05	45	287
BOERMFLCG14	14	10.05	48	289
BOERMFLCG15	15	11.05	52	293
BOERMFLCG16	16	11.05	54	347
BOERMFLCG17	17	12.05	56	348
BOERMFLCG18	18	12.05	60	352
BOERMFLCG19	19	12.95	64	354

